

AIR HANDLING UNIT WITH AN INTEGRATED HEAT PUMP



MANDÍK®

AIR HANDLING UNIT

WITH AN INTEGRATED HEAT PUMP

Description of the Unit:

The air handling unit with an integrated reversible heat pump is a variant of standard air conditioning units produced by MANDÍK as M and P lines.

By appropriate combination of used chambers and their relative position, and by adding the heating pump circuit, new quality and possible functions of the whole set are achieved. The heat pump circuit that includes the heating and cooling functions is made of quality components in order to achieve high effectiveness and reliability of operation.

Casing of the Unit:

Original frameless self-supporting design. The casing wall thickness of 50 mm.

The parameters of the casing of the unit comply with the EN 1886 standard. Tests were carried out by TÜV SÜD Munich:



Mechanical stability: D1 (M)

Leak between the filter and the frame: < 0,5 % – F9 (M)

Variants of casing:

Thermal isolation	Thermal bridges	Tightness
T3	TB2	L1
T2	TB1	L1
T1*	TB1*	L2*

* In this variant we have panels 100 mm thick

Casing attenuation in band:

Hz:	125	250	500	1000	2000	4000	8000
dB	14	23	26	36	38	40	47

Design:

Indoor design.

orm to the needs of outdoor installation (roofs, painting, exhaust extensions, etc.).

The air conditioning units produced by MANDÍK can be designed so as to comply with up to the A+ energy class and fitted with the certified energy labels meeting the requirements of the Eurovent and RLT companies.



RLT-TUV-01 energy efficiency certificate



TUV SUD testing protocol



Electromagnetic compatibility certificate for the living and industrial environments



Mandik air conditioning units electrical safety certificate, including for the MaR system



Product certificate



ISO 9001



KTA 1401

Output range:

Air output from 500 to 40,000 m³ /h.

Regulation:

An autonomous measurement and regulation system using the Siemens platform. Employment of the scroll compressors, either without the module regulation with the frequency changer or with smooth digital regulation using the signal 0–10 V.

Delivery:

Distinguishing by the size of the units and transport possibilities, the unit can be delivered in the following variants:

- 1) The heat pump circuit / cooling circuit is assembled and pre-filled with the refrigerant in the factory. This means that the chambers of the evaporator, condenser, compressor and, as the case may be, of the recuperation exchanger may be assembled and delivered as a set on a common frame.
- 2) The heat pump circuit / cooling circuit is assembled, but it is interrupted at the flanges of the individual chambers. This means that the chambers of the evaporator, condenser, compressor or, as the case may be, of the recuperation exchanger are delivered separately and it is necessary, after the installation, to weld the circuit at the spots where it is interrupted and to fill the circuit with the refrigerant.
- 3) Plug&Play design. This means that the unit is completely assembled and mounted on the common frame; the heat pump circuit / cooling circuit is assembled and filled with the refrigerant. The MaR system is completely connected and tested.

Advantages of this solution:

The unit designed to include the reversible heat pump is on the list of exceptions from the EU Commission Regulation EU 1253/2014 concerning the ecodesign requirements for ventilation units.

High efficiency and low operational costs. Space-saving design – the external condenser unit is not necessary and the refrigerant pipes do not have to be lead through the structural components of the building.

The compressor circuit is filled with the environmentally friendly refrigerants R407c or R410a.

Short length of the refrigerant distribution pipeline – which saves the amount of the refrigerant and the materials.

AIR HANDLING UNIT WITH AN INTEGRATED HEAT PUMP WITH REVERSIBLE OPERATION



Types of the used compressors:

Air conditioning units by Mandík with an integrated heat pump are primarily equipped with the scroll type compressors.

A scroll compressor contains two screws that move in an asymmetric manner in relation to each other, thanks to which the gaseous refrigerant is conveyed and compressed. There are two types of these scroll compressors in the Mandík's portfolio; the main difference between them consists in the regulation of the cooling/heating output – on/off regulation or modular regulation.

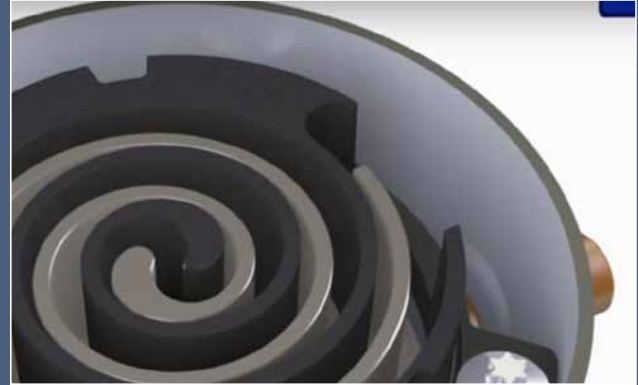

The Principle of Functioning of the On/Off Regulation

It is a standard version of the scroll compressor with output regulation performed through the frequency changer. The output of the standard compressors with the frequency changer may be regulated in the range from 40 Hz to 60 Hz. Standard scroll compressors may be connected to the cooling circuit either separately or in tandem with other scroll compressors without the modular regulation. Tandem assemblies provide better and smoother output regulation up to the amount of over 100 kW of cold to the compressor circuit.

The Principle of Functioning of the Digital Modular Regulation

The digital modular regulation of the scroll compressors consists in the principle that the two internal screws move away from each other in the vertical direction creating space between them through which the refrigerant may flow; that negates the compression for a certain period of time. At that moment, the refrigerant is not pushed further to the refrigerant circuit but returned back to the compressor intake through the by-pass and the solenoid valve.

The output of the digital scroll compressors may be modulated in the range from 20 % to 100 % with the control via the signal 0–10 V. The compressors are able to ensure very precise regulation based on the required output temperature up to $\pm 1,0$ Kelvin.

Digital scroll compressors may be connected to the cooling circuit either separately or in tandem with standard scroll compressors without the modular regulation. The control works in a way that the standard compressor (on/off) is switched on only at the moments when the output of the digital compressor does not meet the actual output requirement.



Advantages of the Digital Modular Regulation:

- The life of the compressors is not shortened due to being turned on and off all the time while trying to regulate the output.
- Lower price and less complicated connection in comparison with the inverter compressors.

Types of Refrigerant Circuits:

Mandík, a.s. offers two variants of the refrigerant circuits:

- Single-direction one intended for cooling only;
- Reversible one intended for both cooling and heating (heat pump).

A Single-direction Refrigerant Circuit Intended Only for Cooling:

A single-direction compressor circuit intended only for cooling contains standard elements such as a thermostatic expansion valve, refrigerant collector and a filter drier. Of course, safety elements such as pressure control sensors and service valves are incorporated in the circuit.

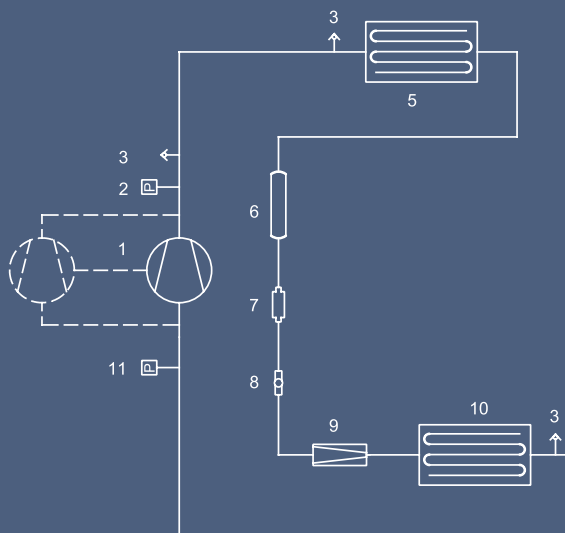

Legend

- | | |
|-------------------------|-------------------------|
| 1 compressor | 9 expansion valve |
| 2 pressure switch – HP | 10 evaporator |
| 3 service valve | 11 pressure switch – LP |
| 5 condenser | |
| 6 refrigerant collector | HP high pressure |
| 7 filter drier | LP low pressure |
| 8 sight glass | |

A Two-way Refrigerant Circuit Intended for Both Cooling and Heating

The compressor circuit is designed as a bidirectional and contains elements adapted to that purpose such as a four-way valve, a bidirectional electronic expansion valve or a bidirectional filter drier and a refrigerant separator. Of course, safety elements such as pressure control and overheating sensors and service valves are again incorporated in the circuit.

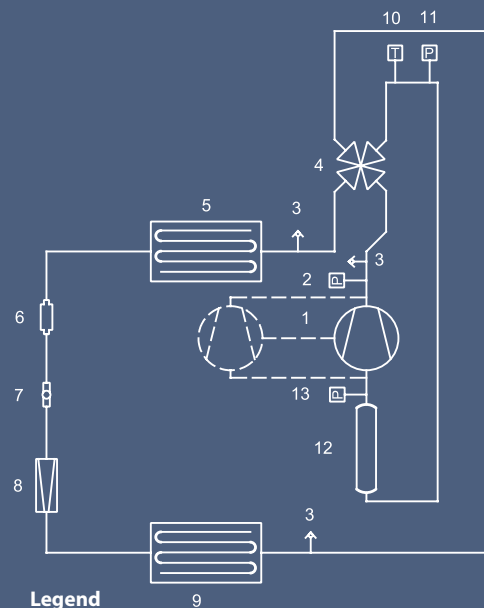

Legend

- | | |
|------------------------|----------------------------------|
| 1 low pressure | 10 sensor of the EEV overheating |
| 2 pressure switch – HP | 11 sensor of the EEV overheating |
| 3 service valve | |
| 4 four-way valve | |
| 5 condenser | |
| 6 filter drier two-way | 12 sensor of the EEV overheating |
| 7 sight glass | 13 sensor of the EEV overheating |
| 8 two-way EEV | |
| 9 evaporator | |

EEV electronic expansion valve
HP high pressure
LP low pressure



Refrigerant Types:

When designing the cooling circuit, it is possible to choose from two types of the refrigerant – R410a or R407c

CONFIGURATION 1

(CONDENSER BEHIND THE HEAT RECOVERY)

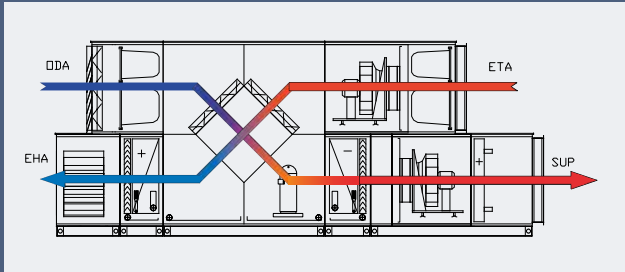

Summer Operation Regime of the Unit

Cooling in Summer is first done by the heat (cold) recovery by recuperation, especially in cases when the outside temperature is higher than the temperature extracted from the building (room).

If the recuperation output is not sufficient, cooling by means of an integrated cooling compressor circuit is turned on; there the inlet air is subsequently cooled down by passing through the direct cooler of the heat pump.

On the other hand, the air is heated even more on the condenser in the outlet section of the unit after recuperation and the hot waste air is exhausted to the atmosphere.

Mixing is not allowed in this case.

Winter Operation Regime of the Unit

Pre-heating of fresh air is realized through heat recovery by recuperation. If the output of the recuperation does not suffice, it can be complemented by mixing the outlet and fresh air. If even this function is not sufficient, heating by the condenser of the compressor circuit is turned on. Although the temperature of the waste air past the air recuperation is already quite low (sometimes less than 0 °C), there still remains much energy that can be taken from the air. Energy taken in this way can then be transferred, through the refrigerant circuit, to the inlet air via the condenser. Mixing is not allowed when the heat pump is in operation.

Defrost function and Bivalent Source

The compressor circuit is equipped with an automatic defrost system by means of operation reversing.

Due to that, it is recommended to equip the air handling unit by a bivalent source of thermal energy to be used during the time when the outside temperature is extremely low. Most often, it is a water or electrical auxiliary heating device. This source may also be used in situations when the heat pump output is not sufficient for the required temperature of the inlet air.

Pros and Cons

- + The advantage is that the waste heat (cold) is maximally exploited over the whole year.
- The disadvantage is that icing appears during the extremely low temperatures in Winter and the backup heat source is necessary.

CONFIGURATION 2

(CONDENSER IN FRONT OF THE HEAT RECOVERY)

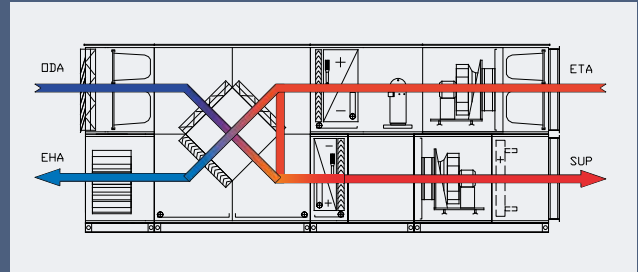

Summer Operation Regime of the Unit

Cooling in Summer is first realized by means of the heat (cold) recovery by recuperation. If this method of cooling is not sufficient, the by-pass of the heat recovery opens (and, as the case may be, the heat recovery is turned off), the air is not recuperated and cooling only by the integrated cooling compressor circuit is turned on.

Summer cooling of the air is done by passing through the direct cooler of the heat pump.

On the other hand, the heat is transferred to the air only on the condenser in the outlet section of the unit and the hot waste air is exhausted to the atmosphere.

Winter Operation Regime of the Unit

The outlet air first transfers part of the thermal energy to the direct cooler and then the already slightly cooled down air (sometimes even below 10°C) flows through the recuperator. Even if the temperature of the outlet air is lower than usually, there is still plenty of energy to be recuperated.

The fresh air is thus first pre-heated in the recuperator and then the energy acquired by the direct cooler of the compressor circuit at the outlet is given to the inlet air through the heat pump condenser.

Defrost function and Bivalent Source

In this configuration, it is very unlikely that icing would appear on the direct evaporator, so the compressor circuit does not have to be equipped with the defrost protection by means of the operation reversing.

For this configuration, it is not necessary to employ a bivalent source of energy. The heat pump should work over the whole year.

Pros and Cons

- + The advantage is that the compressor circuit operates without any problems over the whole year.
- + The compressor always works at the temperature when the heat pump is maximally efficient.
- The disadvantage of this system is the absence of the summer pre-heating through recuperation.

EXAMPLE OF THE HEAT RECOVERY AIR HANDLING UNIT WITH AN INTEGRATED HEAT PUMP WITH REVERSIBLE OPERATION

Description of the Unit:

The air conditioning unit MANDÍK – M11 product family
A+ energy class

Integrated heat pump with reversible operation as
a source of heat and cold.
Plate type recuperating heat exchanger (heat recovery)

General Technical Parameters of the Unit:

Nominal air flow: 10,000 [m³/h]
Air flow velocity: 2.5 [m/s]
Summer parameters of outside air for the purpose
of calculations: 32 °C, 40 %
Winter parameters of outside air for the purpose
of calculations: -15 °C, 90 %
Summer parameters of inside air for the purpose
of calculations: 25 °C, 50 %
Winter parameters of inside air for the purpose
of calculations: 22 °C, 45 %
Inlet air filtration class: M5
Outlet air filtration class: M5

Fans type: EC
External pressure loss: 350 Pa
Working frequency of the fans: 50 [Hz]
Compressor type: Scroll compressor
Number of compressors: 1 [pc]
Voltage: 400/3/50 [V/Ph/Hz]
Refrigerant: R410a
Amount of the refrigerant: 13 [Kg]

CALCULATION FOR CONFIGURATION 1

Technical Parameters in Winter:

Plate type recuperating heat exchanger efficiency ϕ : 73.3 [%]
Heating output of the heat recovery: 91.0 [kW]
Inlet fan power input: 3.80 [kW]
Outlet fan power input: 4.25 [kW]
Maximum heating output of the heat pump: 29.7 [kW]
Compressor input: 6.3 [kW]
Inlet air temperature: 21.0 [°C]
COP: 4.7 [-]

Total power input at the operating point: 14.35 [kW]

Design output of the bivalent source at 50-percent mixing
of the outlet air: 11.4 [kW]

Technical Parameters in Summer:

Plate type recuperating heat exchanger efficiency ϕ : 68.5 [%]
Cooling output of the heat recovery: 14.0 [kW]
Inlet fan power input: 3.80 [kW]
Outlet fan power input: 4.25 [kW]
Maximum cooling output of the heat pump: 31.0 [kW]
Compressor input: 7.3 [kW]
Inlet air temperature: 21 [°C]
EER: 4.2 [-]

Total power input at the operating point: 15.35 [kW]

CALCULATION FOR CONFIGURATION 2

Technical Parameters in Winter:

Plate type recuperating heat exchanger efficiency ϕ : 73.3 [%]
Heating output of the heat recovery: 91.0 [kW]
Inlet fan power input: 3.83 [kW]
Outlet fan power input: 4.31 [kW]
Maximum heating output of the heat pump: 51.2 [kW]
Compressor input: 8.9 [kW]
Inlet air temperature: 21.7 [°C]
COP: 5.7 [-]

Total power input at the operating point: 17.05 [kW]

Without a bivalent source.

Technical Parameters in Summer:

Plate type recuperating heat exchanger efficiency ϕ : 68.5 [%]
Cooling output of the heat recovery: 14.0 [kW]
Inlet fan power input: 3.83 [kW]
Outlet fan power input: 4.31 [kW]
Maximum cooling output of the heat pump: 43.6 [kW]
Compressor input: 9.9 [kW]
Inlet air temperature: 21 [°C]
EER: 4.4 [-]

Total power input at the operating point: 18.05 [kW]

ASSEMBLIES OF THE AIR HANDLING UNITS WITH AN INTEGRATED HEAT PUMP IN CONFIGURATION 1

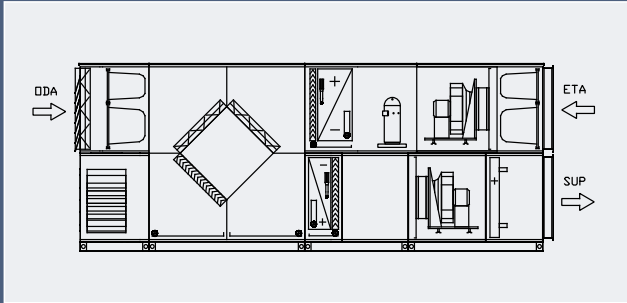

Unit with the cross-flow plate type recuperating heat exchanger and the heat pump (vertical design)

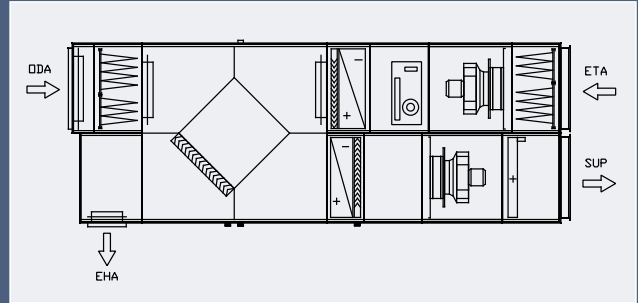

Unit with the cross-flow plate type recuperating heat exchanger and the heat pump (horizontal design)

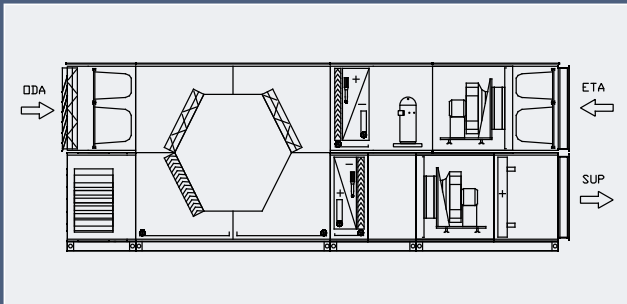

Unit with the counter-flow plate type recuperating heat exchanger and the heat pump (vertical design)

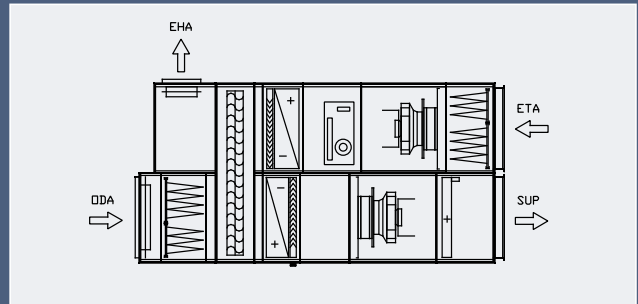

Unit with the rotary recuperating heat exchanger and the heat pump (horizontal design)

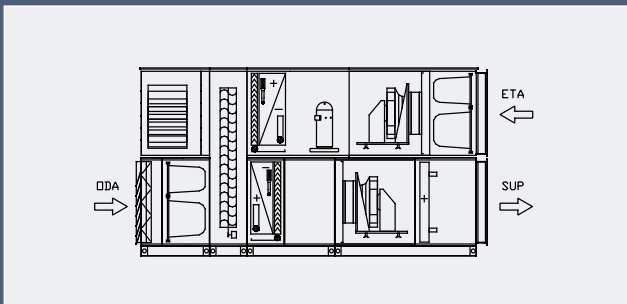

Unit with the rotary recuperating heat exchanger and the heat pump (vertical design)

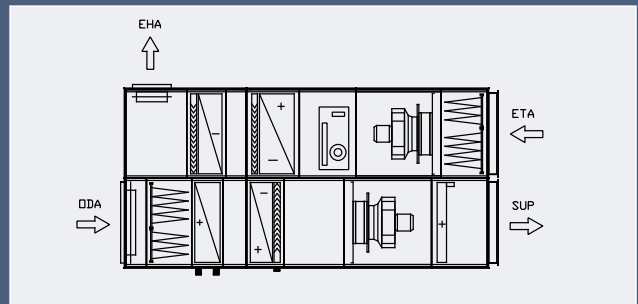

Unit with the liquid-based recuperating heat exchanger and the heat pump (horizontal design)

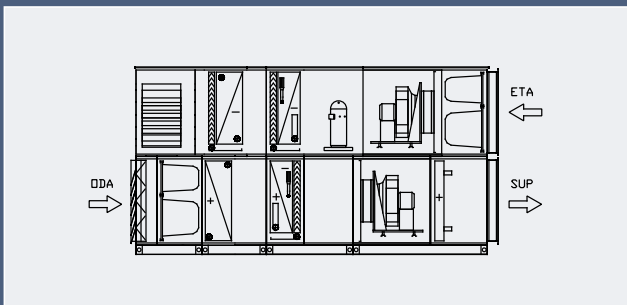

Unit with the liquid-based recuperating heat exchanger and the heat pump (vertical design)

ASSEMBLIES OF THE AIR HANDLING UNITS WITH AN INTEGRATED HEAT PUMP IN CONFIGURATION 2:

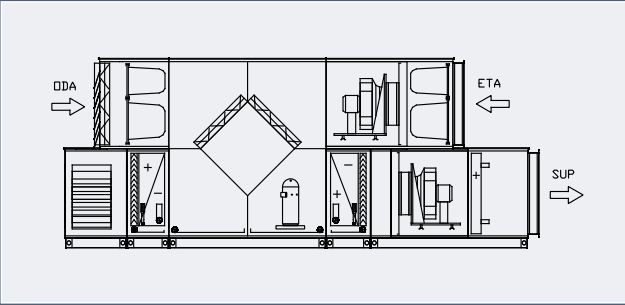

Unit with the cross-flow plate type recuperating heat exchanger and the heat pump (vertical design)

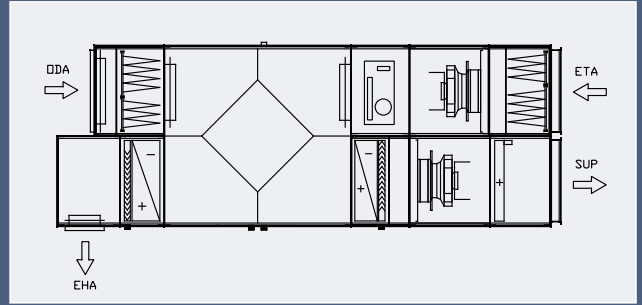

Unit with the cross-flow plate type recuperating heat exchanger and the heat pump (horizontal design)

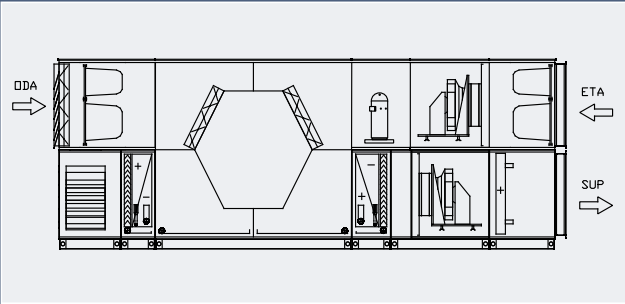

Unit with the counter-current plate type recuperating heat exchanger and the heat pump (vertical design)

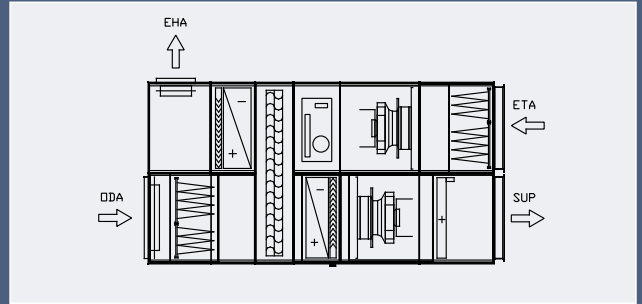

Unit with the rotary recuperating heat exchanger and the heat pump (horizontal design)

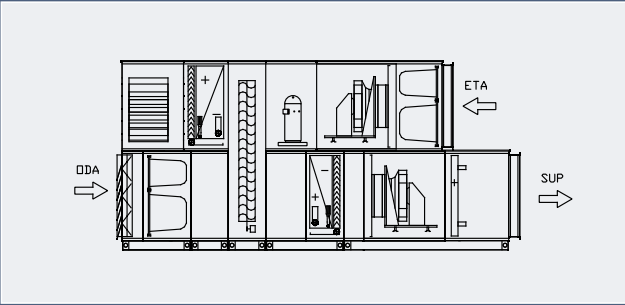

Unit with the rotary recuperating heat exchanger and the heat pump (vertical design)

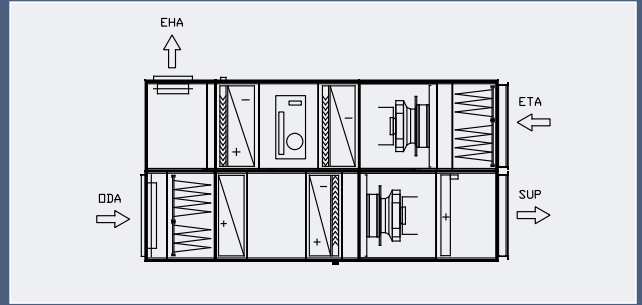

Unit with the liquid-based recuperating heat exchanger and the heat pump (horizontal design)

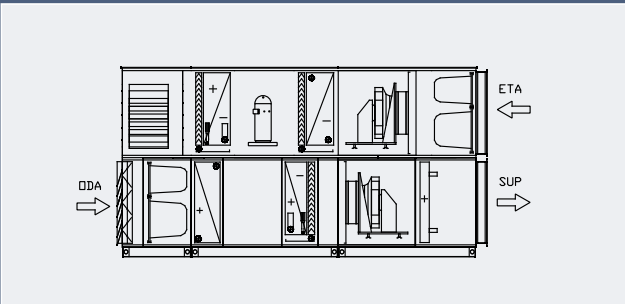

Unit with the liquid-based recuperating heat exchanger and the heat pump (vertical design)

MANDÍK, a. s.

Dobříšská 550

267 24 HOSTOMICE

Czech Republic

Tel. +420 311 706 706

E-mail: mandik@mandik.cz

www.mandik.cz

Date of issue: March 2020